



The SLS AMG Coupé and Roadster.



Mercedes-Benz

front mid-engine with a drive system featuring a transaxle configuration for optimum v  
n the road in it. **SLS AMG Coupé/Roadster.** These doors hold the keys to hearts that beat  
a standstill it would be a massive understatement to describe the SLS AMG simply as  
ating, powerful, breathtaking. In the SLS AMG Coupé you feel as though you're driving  
w weight with the highest possible rigidity. The result: superb driving dynamics. And  
l clutch transmission in the SLS AMG shifts in less than 100 milliseconds - without a  
ght - faster. The finest hand-sewn nappa leather. Solid metal or optional genuine carb  
e up with so few reasons to get out. It's not just the engine output that gives the driver  
teering wheel and in the centre console the AMG DRIVE UNIT with the E-SELECT sele  
where in the cockpit the driver sees and feels materials that underline the handcrafted  
rcraft's cockpit, and the passenger cell is like a well-fitting helmet. All in all: a unique  
ecification naturally aspirated V8 engine - a promise that this super sports car is only

weight distribution and a sophisticated high-tech chassis – all this ensures handling of  
t faster when it comes to pure automotive design. Creative ideas on loan from aircraft co  
a “car”. An impression that is more than confirmed whilst driving – because beneath  
g a racing car – only with a cup holder and automatic climate control. The AMG high-  
a distinct feeling of butterflies – over and again. Anyone who’d been hoping to take a  
ny interruption to the power delivery. Acceleration like this calls for a rear aerofoil tha  
on fibre. Everywhere in the cockpit the driver sees and feels materials that underline  
the feeling of sitting in a jet – the interior does, too: AMG sports seats with perfect la  
ector lever, reminiscent of the thrust lever in a jet. “It’s a car”, says the voice of reason  
d character of the SLS AMG. The SLS AMG places its driver low and breathtakingly cl  
e driving feel. **SLS AMG GT Coupé/Roadster.** Impressive on paper, overwhelming on  
y too happy to keep, as soon as you so much as tap the accelerator. And it delivers yet m



## The stuff that dreams are made of: black-and-white chequer.

Right from the outset the Mercedes-Benz brand has stood for sporting successes as well as comfort and luxury. Cars bearing the three-pointed star have always proven their performance over and over again – on the road and on the race track. The year is 1900. The first vehicle to go by the name “Mercedes” is delivered. It is the first modern-day car. It has an output of 35 hp. And it is a racing car. In 1952 the 300 SL, the legendary gullwing model, first saw the light of day – and as the victorious winner it saw the chequered flags at the 24 Hours in Le Mans, the Berne Grand Prix and the Carrera Panamericana – in spectacular fashion. In 1967 the AMG sports car manufactory was founded, and in 1971 it caused a sensation. At the 24 Hours in Spa, the legendary bright-red 300 SEL 6.8 AMG

sped over the finishing line as the champion of its class – and into the history books. Countless victories in various different racing series followed – above all in the DTM.

For some years now the engineers at Mercedes-AMG and Mercedes-Benz have been joining forces to develop the super sports car of modern times. They are striving for the maximum possible – with the same passion as their predecessors but using the technology of the future.

The SLS AMG – the Coupé, the Roadster and the GT models – sees the black-and-white flag fall. The finishing line has been reached. A new legend is born.



Can excitement be divided up into chapters?  
Let's see.

**Featured models:**

SLS AMG Coupé | AMG alubeam silver | From page 6 | 5-twin-spoke AMG light-alloy wheels, designo black Exclusive leather, AMG carbon-fibre trim.

SLS AMG Roadster | AMG Sepang brown | Cover and from page 22 | 10-spoke AMG forged wheels, designo sand/black Exclusive leather, AMG Interior Carbon-Fibre package.

SLS AMG GT Coupé | designo mystic white 2 | Cover and from page 34 | 10-spoke AMG forged wheels, designo black/Alcantara® leather, AMG trim in high-gloss black.

SLS AMG GT Roadster | designo mystic white 2 | From page 40 | 10-spoke AMG forged wheels, designo black Exclusive leather, AMG trim in high-gloss black.

SLS AMG Roadster | AMG alubeam silver | From page 52 | 10-spoke AMG forged wheels, designo sand/black Exclusive leather, AMG Interior Carbon-Fibre package.

---

The illustrations may show accessories and optional extras which are not part of the standard specification.



## Fascination

- 06 SLS AMG Coupé
- 22 SLS AMG Roadster
- 34 SLS AMG GT Coupé
- 40 SLS AMG GT Roadster

## Facts

- 52 AMG
- 56 Drive system
- 62 Chassis & suspension
- 68 Equipment and appointments
- 96 Services
- 98 Facts & figures

A dramatic landscape featuring a stone wall in the foreground, overlooking a vast, hazy valley. The sky is filled with soft, white clouds, and the overall color palette is dominated by blues, greens, and greys. The scene conveys a sense of height and grandeur.

## A cockpit. An engine. Two wings. Is it still a car?

These doors hold the keys to hearts that beat faster when it comes to pure automotive design. Creative ideas from aircraft construction add some thrilling touches. They show that even at a standstill it would be a huge understatement to describe the SLS AMG Coupé simply as a “car”. An impression that is more than confirmed whilst driving – for beneath the auspicious exterior lies sheer motor-racing technology.







It, too, has ejector seats.  
But they catapult the driver forwards, not upwards.

Exhilarating, powerful, breathtaking. In the SLS AMG Coupé you feel as though you're driving a racing car – only with a cup holder and automatic climate control. The AMG high-performance engine ensures impressive

traction, the aluminium space frame low weight with the highest possible rigidity. The result: superb driving dynamics. And a distinct feeling of butterflies – over and again.



## Every paparazzo's nightmare.

Anyone who'd been hoping to take a break during shift delays had better think again. The AMG SPEEDSHIFT dual clutch transmission in the SLS AMG shifts in less than 100 milliseconds – without any interruption to the power delivery. Acceleration like this calls for a rear aerofoil that ensures sufficient downforce. Helping you to get to your destination – or out of sight – faster.



A detailed view of the interior of a Mercedes-AMG car. The image shows the driver's side, including the leather-upholstered seat with white stitching and an AMG logo on the side. The center console features a gear shifter and a handbrake. The steering wheel is also visible, along with the dashboard and door panel. The overall aesthetic is sporty and luxurious.

The only thing that distinguishes it from a jet:  
the undercarriage stays out.

It's not just the engine output that gives the driver the feeling of sitting in a jet – the interior does, too: AMG sports seats with superb lateral support and high long-distance comfort, an AMG performance steering wheel and in the centre console the AMG DRIVE UNIT with the E-SELECT selector lever, reminiscent of the thrust lever in a jet.





## Its cruising altitude? 369 mm above the tarmac.

“It’s a car”, says the voice of reason. “It’s a jet” reply the emotions. The SLS AMG places its driver low and breathtakingly close to the tarmac. The instruments are reminiscent of those in an aircraft’s cockpit, and the passenger cell is like a well-fitting helmet. All in all: a unique driving feel.





## Two wings make it an icon. The third prevents it from taking off.

Even as the unique gullwing doors close above you, you can sense that you are about to become part of a legend. That this legend also sets new standards when it comes to performance and driving dynamics becomes clear at just 120 km/h. This is when the rear aerofoil is extended – for optimum rear downforce at high speeds and on swiftly taken bends. Of course it also puts in an appearance at the touch of a button – showing even at a standstill what the SLS AMG is made for.







An aerial, high-angle photograph of a winding asphalt road that curves through a rugged, mountainous landscape. The terrain is covered in dense, green vegetation, and the sky is filled with large, billowing white and grey clouds, suggesting a dramatic or stormy atmosphere. The road's surface is dark and appears to have a fine texture, possibly a matt finish. The overall scene conveys a sense of dynamic movement and high performance.

Seldom has a lasting value been so dynamic.

With its extremely high performance values an investment in silver is recommended. Or in Imola grey. Or Sepang brown. Or in a further six colours. These include exclusive matt paints manufactured using technology that is as innovative as it is sophisticated: designo magno allanite grey and AMG Monza grey magno – to suit the taste of the pilot – or the driver.



## A spectacle of nature. Unleashed by our engineers.

Raging storms prove to man how powerless he is in the face of nature and how such forces know no bounds. But it is also in the nature of mankind to research precisely these limits, to push them and compete against them. The Mercedes-AMG engineers have succeeded in building an engine whose power does not shy away from comparison with that of the strongest forces of nature; if the SLS AMG were

just a few km/h faster, this would correspond to the highest level on the scale used in the USA to classify whirlwinds. The SLS AMG has gone head to head with the standards used to record the most awe-inspiring natural phenomena anywhere in the world – until there are virtually no more limits left to push. High time for the Mercedes-AMG developers to start looking for a new role model.







Having nothing and no-one above  
you has always been a privilege.

The SLS AMG Roadster unmistakably has the genes of the SLS AMG Coupé, but its character is very much its own. It's a super sports car for which the sky's the limit – and not just when you're driving it with the top down.



## At last we can accurately talk of air travel.

The SLS AMG Roadster blends breathtaking performance with superb driving dynamics – and its driver can feel this in no uncertain terms. In this cockpit the dream of flying even comes true on the road.



## The solar system has a new centre.

All eyes are on nothing but the roadster when it's on the road. The extremely flat and broad body and the striking, elongated lines indicate its enormous forwards thrust even at a standstill. An initial impression which is surpassed during the first few metres of the journey.







Let the sunshine in.  
It's been looking forward to this for 4.5 billion years.

You are met by the finest materials in the SLS AMG Roadster: solid metal, fine nappa leather – and genuine carbon fibre as an option. You can experience all this in the light of the sun at the touch of a button – with a soft top that opens at record speed, as befitting this vehicle.



## A few raindrops like these can't dilute the adrenaline.

The roadster always ensures an all-time high for the driver when it comes to roadholding and acceleration data – no matter what the weather forecast says. The route is irrelevant here, too – thanks to helpers such as the optional AMG RIDE CONTROL sports suspension with its adaptive damping system. It adapts perfectly to the requirements of both the driver and the road surface.











## Just popping out for a breath of fresh air.

The aluminium space frame for a lower weight coupled with high rigidity, a front mid-engine with a drive system featuring a transaxle configuration for optimum weight distribution and a sophisticated high-tech chassis – all this ensures handling of the highest calibre. You will just seize any opportunity you possibly can to be out on the road in it.





The day flew by.  
The night went even faster.

The SLS AMG is already a super sports car that has no equal. But even it can turn a touch sportier – a fact proven by the SLS AMG GT – as a coupé and as a roadster. In both models the heightened driving dynamics are reflected in the design of the exterior and interior, including attractive highlights in high-gloss black and red. A vehicle for all those who prefer going to the limit over switching off for the evening.



## Circumvent the ban on night flights.

The SLS AMG GT is the high-flyer on the tarmac. Even more output than the SLS AMG, a suspension with even sportier tuning and adaptive damping, even faster and more emotive shifting, the most powerful naturally aspirated V8 engine in the world. In combination with the AMG SPEEDSHIFT dual clutch transmission with its Race Start function it ensures unique driving dynamics. Ready to start? Then penetrate the limits of physics with the SLS AMG GT.









## Pressure refuelling. With endorphins.

What a drive. But at a standstill, too, the SLS AMG GT displays a character all its own. Darkened headlamps, a darkened radiator grille, fins in high-gloss black and brake callipers painted red: striking details which make it clear even at first glance that this is no sports car – but an exceptional athlete.

## Like dynamite. Without a fuse.

It's fascinating to watch how the red speedometer needle rushes over the black dial in the SLS AMG GT. The sporty transmission tuning and the indefatigable naturally aspirated V8 engine bursting with power see to that. The result is unbridled acceleration – for your pulse, too.









## Turns constellations of stars into shooting stars.

Absolutely everything about this vehicle is geared towards uncompromising dynamism. And this is particularly evident in its design. Particularly pithy: the 10-spoke AMG forged wheels painted matt black with a high-sheen finish and the “GT” lettering on the tail end. A visual promise that the SLS AMG GT fulfils as soon as you nudge the accelerator pedal.



## A new milestone in civil aviation.

The sophisticated design concept of the SLS AMG GT extends from the exterior to the interior. The fact that it's all about pure sportiness here is underlined by the colours black and red – with trim in high-gloss black plus red belts and topstitching. The hands encircle the easy-grip steering wheel in Alcantara®, a material from motorsport which can also be found in the AMG sports seats and door centre panels. An interior which immediately gets your senses buzzing.

## The technical explanation for dilated pupils.

Over 5800 individual parts, distributed over a length of precisely 464 centimetres and a width of 194 centimetres, covered with up to 16.1 litres of paint. What do these figures have to do with dilated pupils? Normally the pupil dilates in darkness, so that more light can fall on the retina – this is the only way the eye can take everything in. This is simply the body’s way of reacting to a physical variable. But a dilated pupil can also be an emotional reaction, as scientists discovered in the 1970s: as soon as we are deeply moved and emotionally charged by something,

our brain – or, to be more precise, the limbic system – sends signals to the eye, and the pupil widens. And that’s how come a future driver will have the designers’ work to thank for the first physical reactions the vehicle provokes – even before they have had a chance to experience the acceleration and centrifugal forces. When the gullwing doors then fold out or the soft top opens up, the pupils become even bigger – a sign that the body is saying: “Give me more! I want to see every last detail.”







Upholstery and trim. In the event of an accident. Metallic paints. Sound system. Petrol engines. Chassis & suspension. Optional extras. Fuel consumption. Interior. In the event of danger. LED headlights. ESP<sup>®</sup>. Dimensions. Standard equipment. Light. Multimedia systems. Drive system. Gearbox. Transmission. Surround sound system. Wheels. Interior. Safe driving. CO<sub>2</sub> emissions. Assistance systems. BlueEFFICIENCY. In an accident. Metallic paints. Petrol engines. Sound system. Chassis & suspension. Optional extras. Fuel consumption. Interior. Airbags. In the event of danger. ESP<sup>®</sup>. Dimensions. Standard equipment. Light. Multimedia systems. Drive system. Package. Transmission. Surround sound system. Wheels. Interior. Acceleration. CO<sub>2</sub> emissions. Safety. Assistance systems. Upholstery and trim. In an accident. Metallic paints. Alloy wheels. Top speed. Optional extras. Chassis & suspension. Fuel consumption. Drive system. Technical data. **The facts.** Paintwork. Total displacement. Climate control. Seats. Dimensions. Appointments. Light-alloy wheels. Memory package. Transmission. Surround sound system.

We're now moving from the emotional to the technical section.  
But you won't notice the difference.



	<b>AMG</b>				<b>Equipment and appointments</b>
52	History			68	Safety features
54	Philosophy			70	Light-alloy wheels
	<b>Drive system</b>			72	AMG Performance Media
56	Vehicle concept			74	Electric fabric top
58	AMG 6.3-litre V8 front mid-engine			76	Paintwork
60	AMG SPEEDSHIFT DCT 7-speed sports transmission			78	Interior equipment and appointments
	<b>Chassis &amp; suspension</b>			84	Standard equipment
62	AMG sports suspension			86	SLS AMG GT equipment
64	Aluminium spaceframe body			88	Optional extras
66	Gullwing doors			92	Multimedia and navigation systems
				93	Bang & Olufsen BeoSound AMG
				94	AMG Performance Studio
					<b>Services</b>
				96	Mercedes-Benz Service
					<b>Facts &amp; figures</b>
				98	Dimensions and technical data



## 45 years of AMG in two minutes. Our customers like life in the fast lane.

High speeds are AMG's special passion. So here are the most important facts about the company - in fast-forward mode. AMG was founded in 1967 as a Swabian two-man engineering firm that built racing engines. The breakthrough came a mere four years later with the class victory at the Spa 24 Hours race in 1971. In 1976 the company moved to its current headquarters in Affalterbach near Ludwigsburg. Since 2005 AMG has been a wholly owned subsidiary of Daimler AG; today it

employs nearly a thousand people and as Mercedes-AMG it is the performance brand of Mercedes-Benz Cars. Mercedes-AMG develops exclusive high-performance models including one-offs which are manufactured in accordance with individual customer requirements. The customers' powers of imagination are what drives the company in its relentless aim to be better and better and continue implementing new, exciting projects.



## The Mona Lisa wasn't painted by five masters either.

An engine that is created at Mercedes-AMG is the product of many clever people's work. And the work of one clever person who is very good with their hands, to be precise. According to the "one man - one engine" principle, one single Mercedes-AMG technician assembles one single engine from start to finish.

They are solely responsible for all the individual work steps - from installing the crankshaft and the wiring to pouring in the engine oil. They meticulously implement the Mercedes-Benz quality criteria. And confirm this with their signature on the engine badge. Just like any true master signs a great work of art.





Handcrafted  
by

*Tobias Schuster*

Mercedes-AMG  
Germany



## We made an exception with this car and paid our engineers to daydream.

When do any engineers normally get the chance to live out their automotive fantasies **without** any restrictions? When they started work the Mercedes-AMG developers sat down **with** that famous blank sheet of paper yet ended up taking advantage of this unique opportunity **in** a record time of just 37 months. The result: a revolutionary super sports car whose **every** detail has been designed with driving dynamics in mind – whether it's a coupé or a roadster. The high-performance AMG engine, just 205 kg when dry, was installed as a front mid-engine – and sits

as low as possible in the vehicle. The drive system with a transaxle configuration helps achieve near-perfect weight distribution between the front and rear axle. And the body was constructed around these key components – as an ultra-light yet extraordinarily rigid structure whose gross weight has been significantly reduced thanks to intelligent optimisation. Pure driving dynamics – better than our engineers could ever have imagined in their wildest dreams.

## Dry sump lubrication. It's our favourite turn of phrase in the entire brochure.

The SLS AMG's design engineers were able to position the engine low behind the front axle by changing over to an unusual type of lubrication technology: this was how they could do without the sump that is usually located beneath the engine. In its place an external oil tank and several pumps supply the engine with lubricant – even during high lateral acceleration. We could fill pages and pages writing about the other performance-enhancing measures that were implemented, so here are the most important ones in a nutshell: a specially developed magne-

sium intake manifold with precisely matched resonance tube lengths for optimum cylinder flow, the use of exhaust headers, significantly lighter forged pistons plus the bucket tappets for a rigid valve train that improves power and torque output. The rest is written all over the faces of euphoric drivers: 6.3-litre V8, 435 kW, 650 Nm torque, acceleration from 0 to 100 km/h in 3.7 seconds, top speed 320 km/h for the SLS AMG GT. Figures can be such fun!





## Cut a fine figure on the race track. In designer sports gear.

With this much engine output, every gear is a revelation. The new AMG SPEEDSHIFT DCT 7-speed sports transmission with an integral rear axle differential lock is in control here. The dual clutch transmission's construction principle comes from the world of motorsport: it consists of two automated dividing gears, each with one clutch. When changing gear, one clutch closes whilst the other one opens simultaneously, so that there is no interruption to power delivery during shifting. Incidentally, all this happens in less than a hundred milliseconds – just as fast as

a racing driver. The driver can choose from four transmission modes: "C" (Controlled Efficiency), "S" (Sport), "S+" (Sport plus) and "M" (Manual). The Race Start function facilitates maximum acceleration from standstill. And for the SLS AMG GT models we have optimised the gear shifting once again. So if you should ever find yourself unable to resist a race track, there's scope for challenging the laws of physics.

## Only the central reservation boasts better roadholding.

Aluminium, steel and motorsport know-how. These are the components that make the SLS AMG's suspension so uncompromising when it comes to driving dynamics. The technical details: dual wishbones with a track rod, and independent wheel and spring location. A long wheelbase ensures straight-line stability and the wide track width more grip on bends. All in all: roadholding you can feel every second of the journey. Plus the rear aerofoil that automatically extends when accelerating from speeds of 120 km/h further improves downforce. And if one perfect suspension system is not enough for you, why not opt for three? The AMG

RIDE CONTROL sports suspension, available as an optional extra, adapts the damping characteristics in line with the driving style and the condition of the road. The driver can select from three suspension modes: Comfort (C), Sport (S) and Sport plus (S+). The SLS AMG GT models offer a suspension that once again optimises the sportiness: the AMG RIDE CONTROL performance suspension. It has been fine-tuned for extreme performance, with tauter springs and dampers for optimised driving dynamics.





## When we build sports cars we try our best to lose. Weight, of course.

Less is not more – it's faster: in order to achieve the lowest weight possible, the designers were consistent in their use of aluminium for the bodyshell of the SLS AMG. The entire aluminium space frame weighs just 241 kg in the case of the coupé and 243 kg in the case of the SLS AMG Roadster. In order to achieve the weight and to render the structure as stable as possible, the engineers optimised the distribution of forces in the structure again and again. Precisely calculated aluminium castings are positioned in places which bear the brunt of high forces.

A mere four percent of the bodyshell is still reinforced with steel – where occupant safety necessitates it. So much stability and safety but so little weight – this could well be a record. And anyone for whom the car still isn't light enough can reduce its weight even further with numerous optional extras: considerably lighter AMG sports bucket seats (available only for the coupé), ceramic brake discs, forged wheels or the extensive use of genuine carbon fibre.



6



## The only door that creates, rather than taking up, room when it opens.

It's fantastic that the SLS AMG Coupé is so super sporty. It's even more fantastic that its driver doesn't have to be. Because the gullwing doors make getting in and out really easy: with an entrance height of 45 cm, a distance between the open door and the ground of 1.50 m and an opening angle of 70°. It's hard to believe the gullwing doors extend outwards no more than 36.3 cm when opening – much

less than a normal car door. And it goes without saying that they can be opened fully in any conventional garage. The driver senses at first glance just how special these gullwing doors are. And so that absolutely nothing impairs the look of the perfect lines, the door handles have been fully integrated, only folding out when they are unlocked.

## High performance is our goal when it comes to safety, too.

The three-pointed star on the SLS AMG's radiator is a sure sign that the weight-reducing measures aren't at the expense of hallmark Mercedes-Benz safety. On the contrary. The basis of the safety concept is the stable aluminium space frame which is reinforced with steel where occupant safety demands it. Also responsible for the high level of safety enjoyed by the driver and passenger are belt tensioners and belt force limiters. And there are no less than eight airbags in total: two adaptive airbags in the front area and two each in the side, head and knee area. Blind Spot Assist is a feature available as an optional extra. When it

detects a vehicle in the blind spot, a red warning signal illuminates in the exterior mirror. If the driver still indicates despite this warning, an alarm also sounds. There are also numerous electronic driver assistance systems taking care of active safety. And, last but not least, there are the driver's dilated pupils. Incidentally, the SLS AMG is also streets ahead where safety in Formula 1 is concerned: as the Official F1™ Safety Car – tested and serviced by the AMG Performance Studio's specialists.





**Standard equipment.**  
7-spoke AMG light-alloy wheels, painted titanium grey and with a high-sheen finish.



**SLS AMG GT standard equipment.**  
10-spoke AMG forged wheels, painted matt black and with a high-sheen finish.



**Optional extra.**  
5-twin-spoke AMG light-alloy wheels, painted titanium grey and with a high-sheen finish.



**Optional extra.**  
10-spoke AMG forged wheels, painted titanium grey and with a high-sheen finish.



**Optional extra.**  
10-spoke AMG forged wheels, painted matt black, rim flange with a high-sheen finish.

## Pity you only ever get a fleeting glance of them as the car speeds by.

There are three different wheel designs available for the SLS AMG. 7-spoke AMG light-alloy wheels are fitted as standard. Optional extras include AMG light-alloy wheels with powerful 5-twin-spoke styling or the weight-optimised 10-spoke AMG forged wheels. All three sets of wheels are painted titanium grey with a high-sheen finish. The 10-spoke design is also available painted in matt black, including a rim flange with a high-sheen finish. As an exclusive optional extra for the GT models

there are 10-spoke AMG forged wheels, painted matt black and with a high-sheen finish. Every wheel brings its own interpretation of the supersport theme; what they all have in common is a design that allows you to look through the spokes so you have an excellent view of the generously dimensioned AMG high-performance compound brake system. For this, too, is certainly a sight worth seeing.





SLS AMG standard equipment.  
AMG high-performance compound brake system.



SLS AMG GT standard equipment.  
AMG high-performance compound brake system  
with red-painted brake callipers.



Optional extra.  
AMG ceramic high-performance compound brake system.

## A stopping distance that is shorter than your wildest expectations.

The AMG high-performance compound brake system offers outstanding deceleration performance and precise brake control. Its character especially shines through in the super sporty SLS AMG GT models, as their brake callipers are painted red. The AMG ceramic high-performance compound brake system is available as an option on all the models for motorsport-style braking power. Its discs are characterised by their extreme hardness as they are made of

carbon-fibre-reinforced ceramic. This reduces the weight of the brake discs by 40%, improving steering behaviour, whilst also facilitating shorter braking distances, higher fatigue strength and a longer life. At a standstill you can recognise the ceramic brake by the specially painted brake callipers.





Optional extra.  
AMG Performance Media, torque, output and accelerator position display.



Optional extra.  
AMG Performance Media, internet function.



Optional extra.  
AMG Performance Media, race-lap analysis.

## We've combined two of the world's fastest systems: www and AMG.

Lap and intermediate times, oil temperature, centrifugal forces, accelerator pedal position, output and torque – professional racing drivers receive these data from their pit crew. SLS AMG drivers can get them from the optional AMG Performance Media system. The system keeps the driver updated on important vehicle data

and times. What's more, it stores all these data so that they can be analysed and compared at a later time. In addition, the AMG Performance Media system allows unrestricted high-speed internet access, enabling you to use search engines, for example. Who'd have thought that data processing could be this exhilarating?





Fabric top in black.



Fabric top in beige.



Fabric top in red.

## The sky has many colours – we've added another three.

In this car the sky is always pristine – even on those days when it's not blue. The soft top consists of high-quality three-ply fabric and is available in black, beige and red. In its closed state it blends perfectly with the vehicle's lines – a feast for the eyes of all fans of classic roadster design. But the soft top meets the most discerning requirements in more than just visual terms. It features a textile rain

groove integrated into the side edges of the soft top, through which the water can drain away from the vehicle. The heated rear window and the optimum thermal and sound insulation make the roadster much more than just a fair-weather vehicle. And in a changeable climate the soft top opens or closes fully electrically in 11 seconds – even during the journey up to a speed of 50 km/h.

## Standard



obsidian black



fire opal



iridium silver

## designo



designo magno allanite grey



designo mystic white 2

## Paintwork.

Just for a change the SLS AMG makes something weigh heavily on your mind: choosing from a total of nine paint colours. There are three paints available as standard: the non-metallic paint fire opal and the two metallic paints obsidian black and iridium silver. As an optional extra you can choose between two

designo paints – the satin-finish paint designo magno allanite grey and designo mystic white 2 – plus five other exclusive AMG paints, some of which are named after the most famous race tracks in motorsport history – Monza, Sepang and Imola. Even though your decision is not an easy one, it will be the right one.

AMG



047

AMG alubeam silver



054

AMG Monza grey magno



491

AMG Sepang brown



756

AMG Imola grey







## Rarely can a co-pilot have clung on to such exquisite appointments.

The driver might not get much of the landscape flying past outside – but the fine interior certainly makes up for this. The AMG sports seats are made of hand-sewn nappa leather and boast contrasting topstitching – as do the dashboard, door panelling and armrests. The roof lining and the A- and

C-pillar trim are in anthracite-coloured Alcantara®, the footwell and rear panel are covered with a black velour carpet. So it may well have absolutely nothing to do with driving dynamics if the co-driver comes over all touchy-feely.

## designo Exclusive leather, single-tone



501

black  
(SLS AMG Coupé/Roadster only)



511

black  
(SLS AMG GT Coupé/Roadster only)



504

espresso brown



505

sand



507

classic red



515

porcelain

## Colours and materials.

The AMG sports seats' backrests consist of high-strength magnesium, with good lateral support – even when the going gets sporty – courtesy of deeply contoured side bolsters. That's the inner values taken care of. Craftsmanship and love of detail can be seen and felt on the exterior of the seats, too. This applies to the standard-fit appointments in all the models and the optional extras in equal measure.

The latter are in designo Exclusive leather and come as a single- or two-tone variant or natural leather with a woven leather insert. You might spend much of your time driving against the clock, but you should take all the time you need for this difficult decision.

designo Exclusive leather, two-tone



554

espresso brown/black



555

sand/black



557

classic red/black



565

porcelain/black

Natural/woven leather



204

designo Exclusive leather  
in light brown



Single-tone designo Exclusive STYLE leather



524

mocha brown/porcelain



527

mystic red/porcelain



528

titanium grey pearl/porcelain

Two-tone designo Exclusive STYLE leather



574

mocha brown/porcelain



577

mystic red/porcelain



578

titanium grey pearl/porcelain

## Well we're not small-minded when it comes to output, either.

The SLS AMG gives you plentiful resources of power when you're out on the road – and in the interior you can draw on plentiful resources of appointments: with the designo Exclusive STYLE leather with a hand-finished character. The fascinating shimmering of the leather and contrasting colours lends the interior additional elegance and class. Manufactured totally in accordance with your individual requirements, the extensive designo Exclusive STYLE Leather package comprises the design of the entire interior. Whether it's exciting contrasts in the dashboard,

the exclusive diamond quilting in the seat and door centre panels or the intricately detailed design of the steering wheel, sunblinds or rear panel and carpet. No matter how you combine the base colour, porcelain, in any one of three single- and two-tone variants with mocha brown, titanium grey pearl and mystic red – the result is always a contemporary interior that gives you a fast look that won't fade in a hurry. The best choice for ensuring that the SLS AMG is an eye-catcher inside as well as out on the road.



The AMG DRIVE UNIT with E-SELECT selector lever and KEYLESS-GO start function.



AMG instrument cluster with 7-LED upshift indicator.



AMG heated sports seats in designo nappa leather.



Door sill panels in vehicle colour with nappa leather insert and embossed AMG lettering (illustration depicts coupé).

## SLS AMG standard equipment | Selection.

Standard equipment for the SLS AMG includes a solid-metal centre console incorporating the AMG DRIVE UNIT, the E-SELECT selector lever and the KEYLESS-GO start function. Not to mention the luxury automatic climate control THERMOTRONIC, the PARKTRONIC parking aid, the COMAND APS multimedia

system with LINGUATRONIC, and the AMG instrument cluster with white-backlit round dials, an upshift indicator, silver-coloured dials, red needles and a 360 km/h scale. Also part of the standard equipment are features such as the heated AMG sports seats upholstered in black hand-sewn nappa leather with



Bi-xenon headlamps with integral LED daytime running lamps.



Screw-on solid-metal fuel filler cap.



Rear bumper with fully integral tailpipe trims.

contrasting topstitching, the AMG performance steering wheel with dynamic 3-spoke styling, silver-coloured aluminium shift paddles and a solid-metal insert, the roof lining and A- and C-pillar trims in anthracite-coloured Alcantara®. Standard features for the exterior include bi-xenon headlamps with integral LED

daytime running lamps, a screw-on solid-metal fuel filler cap, 7-spoke AMG light-alloy wheels and a rear bumper with integral tailpipe trims.



Exterior mirror in high-gloss black.



Fins in high-gloss black.



"AMG GT" lettering on boot lid.



Darkened headlamps.

## Standard equipment for the SLS AMG GT | Selection.

Even from afar the hungry character of the SLS AMG GT is recognisable. It adds dark, powerful touches right through to the design of the details. From the exterior mirrors painted in high-gloss black to the fins and the matching radiator grille and the darkened headlamps. In the interior this design is continued, on the black steering wheel covered in easy-grip Alcantara® and its red 12 o'clock

mark plus the contrasting topstitching in dynamic red. And on the high-gloss black ventilation outlets and the door centre panels in Alcantara®. We don't leave the model designation in the dark: "GT" is on the tail end, even though the motorists behind you will hardly have time to read these two letters.





AMG performance steering wheel in black/Alcantara® nappa leather with 12 o'clock mark and red topstitching.



Ventilation outlet in high-gloss black.



AMG trim in high-gloss black.



AMG instrument cluster with black dials.





AMG sports seats in black/Alcantara® designo leather with red contrasting topstitching.



AMG emblem embossed in the head restraints.



Door centre panels in Alcantara® with red contrasting topstitching.



Red seat belts.

## Promotes passengers to co-pilots.

As is the case on the asphalt, sporty drivers also value the perfect blend of flawlessness and grip when it comes to the seat. This is why we cover the centre section of the seat cover on the AMG sports seats with easy-grip Alcantara® for support and comfort. As an optional extra the seats are available entirely in nappa leather. An exclusive feature in the case of black interior appointments comes

in the form of the embossed AMG emblem in the head restraint, red seat belts and red contrasting topstitching on all the dark leather elements. The AMG floor mats with a red leather insert and the AMG instrument cluster with black dials complete the systematically striking interior styling.



AMG carbon-fibre exterior mirrors.



AMG indoor car cover.



AMG carbon-fibre engine compartment cover.



Blind Spot Assist.

## Optional extras | Selection.

Even the utmost in enjoyment can become even more enjoyable. The optional extras offer you a choice of single- or two-tone design. Exclusive leather appointments, or you can opt for a natural/woven leather combination. Also available as options are the AMG performance steering wheel with Alcantara® inserts in the areas of grip, AMG carbon-fibre trim – with a genuine carbon-fibre insert for the centre

console and the door trim strips – or the AMG Interior Carbon-Fibre package with additional carbon-fibre door sill panels and carbon-fibre seat linings. Plus there is an AMG trim painted in high-gloss black available. Further optional extras: an AMG carbon-fibre engine compartment cover, AMG sports bucket seats (only available for the coupé) for optimum lateral support, a Memory package (stores



AMG carbon-fibre trim with genuine carbon-fibre insert for the centre console.



AMG Interior Carbon-Fibre package, AMG door sill panel (illustration depicts coupé).



AMG sports bucket seats.



Fire extinguisher at the front mounted on the driver's seat.

the preferred front-seat, steering-column and exterior-mirror positions for several drivers) and AMG carbon-fibre exterior mirrors. Not to mention Blind Spot Assist, which warns the driver when it registers another vehicle in the blind spot.



Standard equipment.  
Central control panel for COMAND APS.



Standard equipment.  
TFT colour display with 17.8 cm screen diagonal for displaying high-resolution maps.



Standard equipment.  
Media Interface.

## Multimedia and navigation systems.

The COMAND APS multimedia system is fitted as standard on board the SLS AMG. It includes a TFT colour display, six loudspeakers, a DVD drive for audio and video – also available as a 6-disc CD/DVD changer as an option, a Music Register with a 6 GB memory for digital music and a Bluetooth® interface. The display with TFT technology also shows pictures from the optional reversing camera. So

that you can concentrate fully on driving, the COMAND APS multimedia system featuring LINGUATRONIC can be controlled via spoken instructions. Those who want to transfer their files from an MP3 player or smartphone to the multimedia system will also like the optional Media Interface. A further optional extra is the telephone module with Bluetooth® for making telephone calls in comfort.



Optional extra.  
Bang & Olufsen BeoSound AMG sound system,  
250-watt subwoofer.



Optional extra.  
Bang & Olufsen BeoSound AMG sound system,  
illuminated tweeter lens.



Optional extra.  
Bang & Olufsen BeoSound AMG sound system,  
menu display.

## Bang & Olufsen BeoSound AMG sound system.

Looks like the speed record for concert halls has been broken. A high-end surround sound system developed together with Bang & Olufsen specially for the SLS AMG is available as an optional extra. Its 11 high-performance loudspeakers with a total of 1000 watts create astounding acoustics and the two illuminated tweeter lenses are a feast for the eyes. The driver can choose between the “Reference” high-end

studio sound and an expansive surround sound, and the sound fields can even be precisely directed towards the seats with the aid of the digital sound processor (DSP) – specially tailored to the interior of the coupé or roadster. Everything you need for pristine sound and a perfect listening experience.

## As far as we're concerned there's no possible or impossible. Only minor and major challenges.

The AMG Performance Studio was founded in 2006 to make your AMG Mercedes even more individual and even sportier. The thing that really makes our employees' day? When they have to say "I've never come across that before!" if met with a particularly demanding customer requirement, before they set about turning

your idea into reality with zeal. Because our highly motivated specialists regard every request for particular colours or materials, for extravagant appointments or yet more dynamism as a special challenge to which they are only too glad to rise as they fulfil it with passion and meticulous precision.





## Services.

**Mercedes-Benz Financial Services.** Our sophisticated leasing and financing products are tailored to your individual financial needs, giving you the opportunity to drive your dream car while staying financially flexible. Once you have chosen a model, you can enjoy the peace of mind of knowing that both the vehicle itself and our insurance products will keep you particularly well protected. What's more, our range of service products is designed to ensure that your car stays in top shape while offering transparent, manageable conditions. For further details, speak to your Mercedes-Benz dealer, who will be glad to go through the latest financial services and terms and conditions with you.

**Mercedes-Benz mobility.** Your new car comes complete with the promise of feeling safe on the road. But if you should ever need assistance, Mercedes-Benz Service24h is there to help. Just call the freephone service hotline on 00800 1 777 7777<sup>1</sup>. The integrated telematics service, Mercedes-Benz Contact<sup>2</sup>, is even more convenient: a touch of a button is all it takes to contact the Mercedes-Benz customer centre. If you wish, relevant vehicle and position-related data are transmitted at the same time, thereby allowing the centre to react quickly and provide rapid on-site assistance. Also standard with your new car at no extra charge is the Mercedes-Benz Mobilo<sup>3</sup> mobility package. Whether you have lost your key, had a breakdown which cannot be repaired immediately or suffered damage to the vehicle due to an accident or vandalism, Mobilo helps you reach your destination – anywhere in Europe. Whatever is holding you up, you will soon be able to resume your journey.

**Mercedes-Benz Museum.** Discover what has been moving the world for over 125 years, and embark on a fascinating journey through automotive history in the Mercedes-Benz Museum. More than 1500 exhibits covering an area of 16,500 square metres chart the unique heritage and innovative flair of the inventor of the motor car. You will find one automotive legend after another awaiting you: unique pieces such as the oldest Mercedes still in existence from 1902, supercharged cars or the awe-inspiring Gullwings. The museum is a spectacular sight in its own right too, thanks to an architecture that breaks away from traditional concepts and creates an unprecedented sense of space. Welcome to the Mercedes-Benz Museum – a world of innovation. [www.mercedes-benz-classic.com/museum](http://www.mercedes-benz-classic.com/museum)



<sup>1</sup> Alternative: +49 69 95 30 72 77. <sup>2</sup> Requires a factory-fitted radio, connected to an operational mobile phone. The only charge incurred is the cost of the mobile phone call to the landline network. <sup>3</sup> Once the mobility guarantee has expired (four years), Mobilo can be extended to provide cover in the event of breakdown and insurance claims one year at a time for a maximum of 30 years, provided that regular maintenance is carried out by your Mercedes-Benz service partner.

**Test drive.** The unique feeling of driving a Mercedes cannot be put into words – you have to experience it for yourself. Take a test drive and find out first hand how it feels to drive your dream car. Please contact your nearest Mercedes-Benz dealer for details.

**Interactive Owner's Manual and Mercedes-Benz Guides.** The website also offers an interactive tour, enabling you to acquaint yourself with your dream car. You can view key functions in detail, gain an insight into the car's inner workings or look at the benefits of each model. For further details, go to [www.mercedes-benz.de/owners-manual](http://www.mercedes-benz.de/owners-manual). The "Mercedes-Benz Guides" app lets you explore the highlights of the individual models both online and offline. The app is available free of charge from the Apple® iTunes® Store (iOS) as well as the Google Play store (Android).

**Mobile internet.** The whole world of Mercedes-Benz can be explored at any time with your web-capable mobile device – including specially adapted content for both smartphones and tablets. As well as an overview of all the passenger car models, there are insights into the entire brand world along with a wealth of entertainment

offers and direct links to our range of services at [www.mercedes-benz.com](http://www.mercedes-benz.com)

**Mercedes-Benz service contracts.** You need never worry about unexpected workshop costs<sup>4</sup> again: depending on the specific contract, a Mercedes-Benz service contract can cover unforeseen repairs, maintenance or wear parts. As a result, your vehicle stays in great condition – thanks to the Mercedes-Benz quality you can expect from our highly qualified workshop specialists and Mercedes-Benz genuine parts. Your Mercedes-Benz dealer will be pleased to tell you more about the available service contracts and terms and conditions.



**Accident repairs.** Should the worst happen and you find yourself in need of repairs, with the Mercedes-Benz accident repair service you will receive the right assistance for your vehicle and ensure that its high-quality safety features are properly maintained. Whether you need paint, body or glass repair work carried out, the highly trained specialists at your Mercedes-Benz service partner will repair your Mercedes-Benz and get you quickly back on the road again. Further information is available from your authorised Mercedes-Benz dealer.



<sup>4</sup>In accordance with the terms and conditions of the Mercedes-Benz service contracts.

# Dimensions<sup>1</sup> and technical data.

## Coupé dimensions.

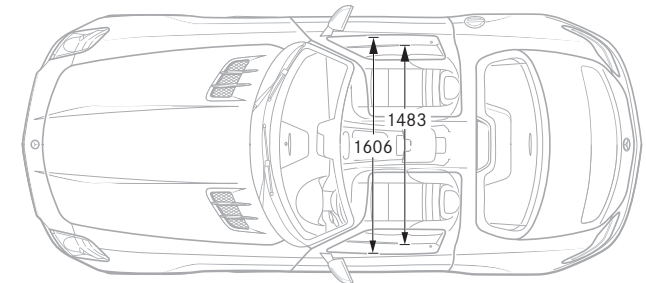
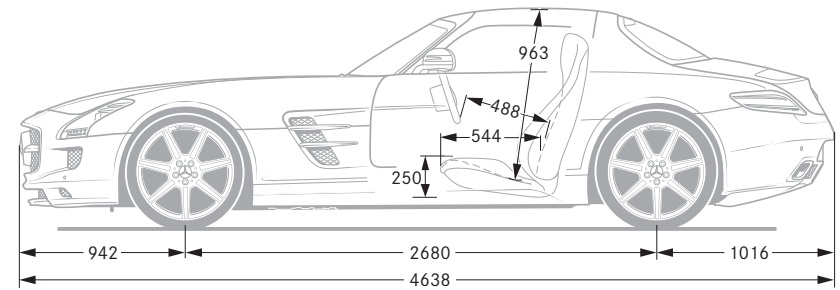
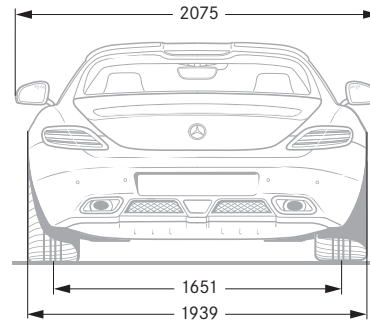
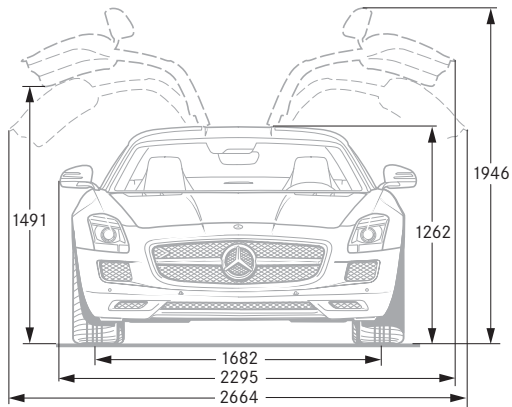

	SLS AMG Coupé/Roadster	SLS AMG Coupé GT/Roadster GT
Arrangement/number of cylinders	V8	V8
Total displacement in cc	6208	6208
Rated output <sup>2</sup> in kW (hp) at rpm	420 (571)/6800	435 (591)/6800
Rated torque <sup>2</sup> in Nm at rpm	650/4750	650/4750
Acceleration from 0 to 100 km/h in s	3.8	3.7

	SLS AMG Coupé/Roadster	SLS AMG Coupé GT/Roadster GT
Top speed in km/h	317	320
Fuel	Super Plus	Super Plus
CO <sub>2</sub> emissions <sup>3</sup> in g/km combined	308	308
Emission class	Euro 5	Euro 5

<sup>1</sup> All measurements in millimetres. The dimensions shown are mean values and apply to standard-specification, unladen vehicles. <sup>2</sup> Figures in accordance with Directive 80/1269/EEC in the currently applicable version. <sup>3</sup> The figures shown were obtained in accordance with the prescribed measuring process (Directive 80/1268/EEC in the currently applicable version). The figures are not based on an individual vehicle and are provided solely for purposes of comparison between different vehicle models. They do not constitute part of the product offer.

# Dimensions<sup>1</sup> and technical data.

## Roadster dimensions.

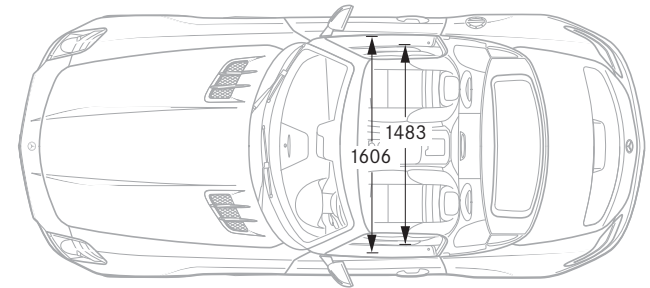
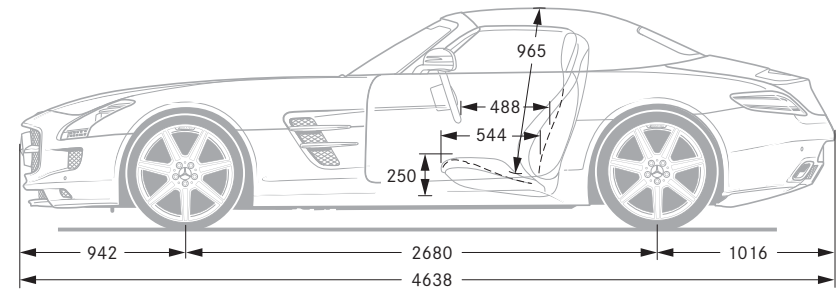
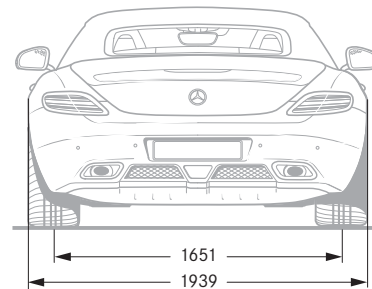
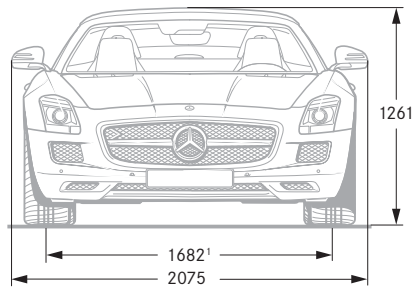

	SLS AMG Coupé/Roadster	SLS AMG Coupé GT/Roadster GT
Fuel consumption <sup>3</sup> in l/100 km		
Urban	19.9	19.9
Extra-urban	9.3	9.3
Combined	13.2	13.2
Tank capacity in l/of which approx. reserve	85/14	85/14

	SLS AMG Coupé/Roadster	SLS AMG Coupé GT/Roadster GT
Tyre size, front	265/35 R 19	265/35 R 19
Tyre size, rear	295/30 R 20	295/30 R 20
Boot capacity in l	176/173	176/173
Kerb weight <sup>4</sup> in kg	1620/1660	1620/1660
Perm. GVW in kg	1935/1960	1935/1960

<sup>1</sup>Figures according to DIN 70020 (kerb weight, fuel tank 90% full, no occupants) for standard-specification vehicles. Optional extras and accessories will generally increase this figure and reduce the payload capacity accordingly.

**Take-back of end-of-life vehicles.** You can return your SLS AMG to us for environment-friendly disposal in accordance with the European Union (EU) End-Of-Life Vehicle Directive. But that day lies a long way off.

A network of vehicle take-back depots and dismantlers has been established to make it as easy as possible for you to return your vehicle. You can leave it at any of these points free of charge and, by doing so, make an important contribution to completing the recycling process and conserving resources.

For further information about the recycling and disposal of end-of-life vehicles, and the take-back conditions, please visit the national Mercedes-Benz website.

**Please note:** changes may have been made to the product since this brochure went to press (05.03.2013). The manufacturer reserves the right to make changes to the design, form, colour and specification during the delivery period, provided these changes, while taking into account the interests of the vendor, can be deemed reasonable with respect to the purchaser. Where the vendor or the manufacturer uses symbols or numbers to describe an order or the subject of an order, no rights may be derived solely from these. The illustrations may show accessories and items of optional equipment which are not part of standard specification. Colours may differ slightly from those shown in the brochure, owing to the limitations of the printing process. This brochure is distributed internationally. It provides a general indication of the range of models, features, optional extras and colours available in various countries. Some of the models, features, optional extras and colours shown may not be available in your country or may only be available in a different specification. Additionally some models, features, optional extras and colours may only be available in combination with others. For current and more specific information in relation to the range of models, features, optional extras and colours available in your country, and their pricing, you should contact your nearest authorised Mercedes-Benz Passenger Car Dealer.

[www.mercedes-benz.com](http://www.mercedes-benz.com)